



Stakeholder Communication Form (Version 01.0)

This form shall be used for any CDM-related communication with the UNFCCC secretariat or the CDM Executive Board. All the questions are mandatory unless otherwise indicated.

The completed form and any supplemental documents shall be submitted electronically to cdm-info@unfccc.int, or via fax to +49-228-815-1999 or via post to: Sustainable Development Mechanism (SDM) Programme, UNFCCC secretariat, P.O. Box 260124, D-53153 Bonn, Germany.

SECTION 1: COMMUNICATION HEADER

Please provide your contact information.

Title: Mr. **First Name:** Ghassan **Last Name:** Afyouni

Name of Organization: Steel Wood Industries FZCO (Dubai Branch) **E-mail Address:** mpi@steelwoodindustries.com

Postal Address: 17260 **Phone Number:** +971-55-838-9104
Country: United Arab Emirates *Include country code (e.g. +49-228-815-1999)*

Stakeholder Type: CDM Applicant Entity (AE) If other:

Please indicate from whom you would like to get an answer.

This communication is addressed to¹: Chair of CDM Executive Board (normal track)

SECTION 2: PROJECT ACTIVITY OR PROGRAMME OF ACTIVITIES (PoA)

If this communication refers to a specific CDM project activity/PoA, please answer questions in this section (otherwise proceed to Section 3).

Project/PoA Ref. Number If applicable, CPA Ref. Number:
5-digit# format 01234 *8-digit# format 0123-4567*

Project Cycle Stage Prior consideration If other:

If there is no specific CDM Reference Number, please answer the remaining questions in this section (otherwise proceed to Section 3).

Host Country(ies) United Arab Emirates

Project/PoA Title Natural Economical Direct Carbon Capture NEDCCS

Technology Type Afforestation/reforestation If other:

SECTION 3: YOUR COMMUNICATION

Title/Subject
Maximum 250 characters Requesting the Inclusion of a Scalable and Economical Carbon Capture System Utilizing the "Burden" Post-Consumer Wood (100%) providing dual commodity; eco-green panels and carbon trade; an eco-enviro-system under the UNFCCC Project Directory.

Communication Text
Include background, details, and conclusion (unlimited length) Dear UNFCCC Secretariat,

We, Steel Wood Industries FZCO (Dubai Branch), are the first and only wood manufacturing facility in the GCC and Arabian Middle East and the first of a kind worldwide to produce composite wood material from 100% post-consumer wood; defying the traditional manufacturing norms and international beliefs that a random-mix of wood can't be recycled maintaining high mechanical properties quoting USEPA-WARM v.14 "wood recycling remains thoretical".

Worldwide panel facilities are specie-specific and Britan sized forests are being depleted anually

¹ In accordance with the "Procedure: Direct communication with stakeholders" (version 02.0), stakeholders may address communications either (a) to the secretariat, in order to seek a fast-track technical or operational explanation regarding the implementation of existing CDM rules, or (b) to the CDM Executive Board, in order to communicate to the Board their views on CDM rules and their implementation, or to seek official clarifications of CDM rules.

	<p>resulting in tremendous disturbances to the ecosystems, air and soil quality, rain cycles, species excintcion etc.</p> <p>With increased population worldwide, the demand across the globe in the timber/lumber sector may deplete our forests in the next century if presently abundant post-consumer wood quantities are ignored.</p> <p>With the previous burden to value in mind, Steel Wood Industries FZCO (Dubai Branch) with their current in-house SDB-technology combines a random-mix wood of 100% FSC/Post Consumer to generate ultra-low emission panels with revolutionary mechanical properties exceeding those published by major international bodies. Thus, SDB production eliminates landfill GHG's and saves equivalent trees covering the evergrowing demand.</p> <p>Steel Wood Industries FZCO (Dubai Branch) has produced a life cycle assesment, an environment product declaration and green house gas quantification in accordance to ISO 14040, ISO 14044, ISO 14025, ISO 14064(1,2,3) and ISO 14067 in-line with ISO 9001:2015 for Quality Management Systems and ISO 14001 for Environmental Management Systems. All the above was done to establish an understanding of the SDB-technology impact on preserving forests utilizing the abundant post-consumer wood available in every municipality worldwide.</p> <p>OpenLCA v.15 and WARM v.14 of USEPA modelled factors at the end of the product life cycle. The calculations is based on forest carbon reduction factor, carbon calculations for virgin production, recycling emissions, landfilling emissions and combustion emissions. The Declaration, attached as a supplemental document, denote that our current capacity pilot-line located in Dubai, United Arab Emirates at 125 CBM/DAY negated (avoided) nearly 1 million metric tons of carbon dioxide on an annual basis. The same project is function for scalability for a line of 3,000 CBM/DAY negating (avoiding) 24,000,000 metric tons of carbon dioxide per annum. Numbers may vary depending on water content of post consumer wood, ambient temperature, location of facility, etc ..</p> <p>With the above being said, Steel Wood Industries defies business-as-usual mills as a competitive commodity as it utilizes post-consumer residues and leftovers. Forestation and Afforestation remain a pillar in the global actions for climate changes as trees naturally photosynthesis; a natural and effective carbon capture system which is the cheapest should the trees be left alone in the natural cycle of life while producing oxygen and offering habitats to species etc. Another hidden problem in climate change is that oxygen depletion is rarely mentioned; however, scientifically, planktons and forests are the "lungs of earth"; thus saving trees opens doors for climate change remedies naturally.</p> <p>Consequently, Steel Wood Industries FZCO has initiated a Natural Economic Direct Carbon Capture System (NEDCCS) that allows for the essential synthesis of oxygen when compared to other synthetic carbon capture technologies; allowing the tree to do its natural job by capturing carbon (saving an equivalent virtual trees for demand), eliminating GHG landfills whilst recycling post-consumer wood into SDB quality products to cover increased demands in the market from a resource that was once a burden to governments, landfills environment etc.</p> <p>Steel Wood Industries model was initiated within the desert dunes of Dubai to prove the abundance of raw material. The success of this model in the desert proves its success once adopted worldwide. In addition, the Steel Wood Industries model is lucrative for both environmentalists and non-environmentalists equally; profit-driven investors would be able to revenue from both commodity and carbon trade in-line with global efforts to correct for climate change. Post-consumer wood, abundant in municipalities worldwide, converted to SDB can protect forests worldwide thus initiating natural carbon capture without burdening economies of governments. In fact, this model has positive economical returns to investors, municipalities, governments, job market etc.; a socio-economical and socio-environmental model accompanied by eco-green process and products.</p> <p>With the above being said, we kindly request the UNFCCC secteriat to include the recycling of 100% post consumer wood (NEDCCS) system as a project into its directory where we as a company can further proceed in initiating Removal Units (RMU)s for international trading purposes.</p>
<p>Supplemental Documents <i>If applicable, list the title(s) of any attached file(s) or link(s)</i></p>	<p>Request Letter Environmental Product Declaration</p>
<p>This communication may be made public</p>	<p>Yes</p>

Document information

<i>Version</i>	<i>Date</i>	<i>Description</i>
01.0	02 March 2015	This form supersedes and replaces the following: <ul style="list-style-type: none">• F-CDM-RtB: <i>Form for submission of Letters to the Board</i> (version 01.2)• F-CDM-RtB-DOE: <i>Form for communication on policy issues initiated by AEs/DOEs</i> (version 01.1)• CDM-RtB-DNA: <i>Form for communication on policy issues initiated by DNAs</i> (version 01.1)

Decision Class: Regulatory

Document Type: Form

Business Function: Governance

Keywords: communications

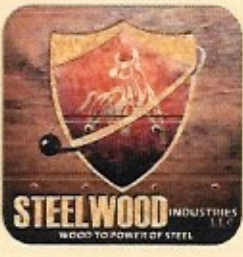

Ref: 201504-SWIDB-UNFCCC-SCF-V.01
Date: April 15, 2020

Sustainable Development Mechanism (SDM) Programme
UNFCCC Secretariat
P.O. Box 260124,
D-53153 Bonn, Germany

Request Letter

Honorable UNFCCC Secretariat,

I am writing this letter on the behalf of Steel Wood Industries FZCO (Dubai Branch) requesting the honorable UNFCCC Secretariat to take into account our request submitted within the Stakeholder Communication Form attached to this letter under the title/subject of;

“Requesting the Inclusion of a Scalable and Economical Carbon Capture System Utilizing the “Burden” Post-Consumer Wood (100%) providing dual commodity; eco-green panels and carbon trade; an eco-enviro-system under the UNFCCC Project Directory.”

Looking forward to your positive response.

Regards,

Ghassan Farouk Afyouni
Managing Partner and Inventor (MPI)
Steel Wood Industries FZCO (Dubai Branch)

STEEL WOOD INDUSTRIES LLC
Dubai Industrial City (DIC)
Warehouses P-13 & P-14
P.O Box 176260
Tel +971 4 880 7576 Fax +971 4 880 7574

www.steelwoodindustries.com



اكتوبر 2020 EXPO



ستيل وود اندستريز ش.م.م
مدينة دبي الصناعية
مستودع P 13 & 14
صندوق البريد 17260 دبي
تليفون: +971 4 880 7576 فاكس: +971 4 880 7574

ENVIRONMENTAL PRODUCT DECLARATION OF STEEL WOOD DENSITY BOARD – COMPOSITE WOOD MATERIAL TYPE IN TERMS OF RESOURCES, EMISSIONS, ENERGY AND CARBON

Steel Wood Industries FZCO (Dubai Branch)

Plot of Land TP010233
National Industries Park

(Received November 4 – Approved November 25)

Abstract. Nowadays, a life-cycle assessment and environmental product declaration is scientifically needed to highlight the performance of materials for applications governed by the uprising green building regulations and standards, strict purchasing guidelines, and energy climate change policy issues. The study allocated here will be directed towards the calculation of negative carbon dioxide or carbon capture due to the recycling of 100% post-consumer wood and wood residuals.

Keywords: Environmental performance, wood products, life cycle assessment, LCA, embodied energy, carbon store, carbon footprint.

INTRODUCTION

The objective of this study is intended to highlight the relation between SDB as a product being from 100% post-consumer recycled wood and Carbon Emission Reduction. The full case-study was done on a Dubai-based mill under the name of Steel Wood Industries FZCO (Dubai Branch). Throughout the full study, reference will be made to WARM V.14 and openLCA V.15 – U.S Environmental Protection Agency of Chapter 10 Wood Flooring and Chapter 11 Wood Products.¹

Composite wood material discussed within this paper is SDB-type which is as per definition an environmental-friendly composite wood material, that is made up of 100% post-consumer recycled random mix of wood species (including SDB waste panels excluding MDF). Trees are not to be cut to manufacture SDB as the raw material need to be 100% unusable wood residues and waste wood. Should there be a non-environmental tree proven and justified by international norms, the manufacturer should not engage in trimming and cutting of the tree and a third party needs to be engaged in such an operation to maintain the chain of custody requirements enforced by the FSC Certification Body or similar. SDB is a recycled material manufactured in an SDB dedicated-intelligent line that produces high mechanical properties when compared to the mother-wood species. (APA Product Report PR-C509).

The LCA performed for SDB is to be done and verified and attested by a third party for Steel Wood

Industries FZCO (Dubai Branch). The data provided within this study are yet to be modelled in WARM pending modelling the SDB-LCA into the NEDCCS model. LCA data are valuable when it comes to establishing whether a product is green in terms of its favorable environmental performance, as a benchmark for improving environmental-friendliness, and for comparison with alternative materials. The data form the foundation for the scientific assessment in terms of a variety of environmental functioning measures. It provides data that can be used to establish the performance of SDB for many green-type product standards, guidelines, and public policies. Issues in which the data can be used are sustainability, global warming, climate change, carbon storage, carbon trading and caps, biofuel use, green-product purchasing, and green building. Should the model widespread, it opens the door for NEDCCS: RGW (Reverse Global Warming) achieving requirements set by UNFCCC to be used as a natural direct carbon-capture method. Re-forestation can be achieved thus increasing the carbon-capture from the atmosphere resulting with time to lowering the greenhouse gases; GHG. The excessive abundancy of post-consumer wood can fill the increasing demands for the growing market. This LCA consists of an accounting of all inputs and outputs of a material from its natural resources in the ground through production of a product and can include downstream transportation, product use, disposal, and/or recycling.

DEFINITIONS

SDB: Steel Wood Density Board Wood Type

Ox-products: brands bred from SDB for specific end-product application and used summarized in the table below:

Table 1- *Ox-products Definitions*

Product	Density Range (kg/m ³)	Replacement	Reference Chapter in WARM version 14
OXFRAME Made from SDB-type composite wood door compatible for fire rated doors	630 – 700 Av: 665	Solid Wood	Chapter 10: Forest Carbon Calculations
OXNAR Made from SDB-type composite wood door compatible for fire rated doors	680 – 700 Av: 690	Composite Wood Material Door (Particle Board) Mineral Cores	Chapter 11: Net Carbon Emission Calculations
OXSAWT Made from SDB-type composite wood door compatible for acoustic panels	650 – 700 Av: 675	Composite Wood Material Door (Particle Board) Mineral Cores	Chapter 11: Net Carbon Emission Calculations
OXNAR-SAWT Made from SDB-type composite wood door compatible for fire-rated and acoustic doors	680 – 740 Av: 710	Composite Wood Material Door (Particle Board) Mineral Cores	Chapter 11: Net Carbon Emission Calculations
OXPANELS Made from SDB-type composite wood panels for wall paneling applications	720 – 800 Av: 760	MDF Panels Chipboard Panels	Chapter 11: Net Carbon Emission Calculations
OXTILES Made from SDB-type composite wood panels for flooring applications	720 – 800 Av: 760	Fire Rated Plywood	Chapter 11: Net Carbon Emission Calculations

PROCEDURE

LCA of manufacturing SDB for this study covers the environmental impacts from the in-ground resources for wood, resin, fuels and electricity through transportation and manufacturing process. This is referred to as a cradle-to-product gate study (Fig 1). The study was conducted for the duration covering October 2018 – September 2019 and done in accordance with ISO 14040 and 14044 protocol (ISO 2006a, ISO 2006b). Primary data were estimated on a one-year full run for a capacity of 125 CBM a day.

MANUFACTURING PROCESS

SDB line manufacturing process is highly automated on an SDB oriented and intelligent production line. The process consists of the following production steps.

Incoming Material: 100% post-consumer wood is delivered by contractors and waste management companies to SWI premises without ending up in landfill. 100% pos-consumer is to include a random mix of used wood that is considered as a raw material. SWI QAQC will inspect the material and accordingly accept or reject it based on the criteria specified in the SDB guidelines; specifically, not to include post-consumer MDF. The material is then stored inside an open yard – based on the FIFO (First in First Out) Method where its MC is averaged to be at 10% weight basis.

Wood Shredding: Accepted sorted wood as per SWI guidelines is passed through a shredder and ferrous metals like nails, clips, etc ... are then separated through magnets. Metal outcome is then sent for recycling through approved list of scrap companies.

Refining: Oversized particles are then refined, a process of mechanically reducing the particle geometry into uniform sizes of desired dimensions; this process is usually accomplished with the use of SWI Intelligent separation system and refining hammermills.

Drying: Particles are sent through SWI intelligent rotary dryers in a single-pass configuration. Particles enter the dryers at moisture content of 7% to 14% oven dry basis and are dried to a targeted MC of about 1 – 5%. Dryers in SWI premises function on green energy and fine rejected dust in furnace consuming around 3tons/24hr. (Normal consumption on non-SWI intelligent line is around 40tons/24hr).

Blending: This is a process in which resin is mixed with dry particles. The average resin content in this study is accounted to be 10% of final board weight.

Forming: Blended particles with glue are then distributed in a SWI intelligent forming machine to form 3 layers (1 core and 2 surface). The size of particles, moisture and resin content are controlled for the face and core layers to obtain the desired panel properties maintaining the SDB guidelines set by APA and CPA.

Hot Pressing: Formed mats are conveyed into a large hot press in which all openings close

simultaneously. The presses operate at enough temperature, pressure and duration to ensure required thermodynamics and kinetics to cure the resin.

Cooling: Hot panels exiting the press are placed on a star cooler wheel to enable the temperature of the panels to drop thus completing the manufacturing process.

Sanding: Panels are sanded on both major surfaces to targeted thickness and smoothness. Sander dust coming of this process is either recycled back into the process or is used as a fuel for the dryers.

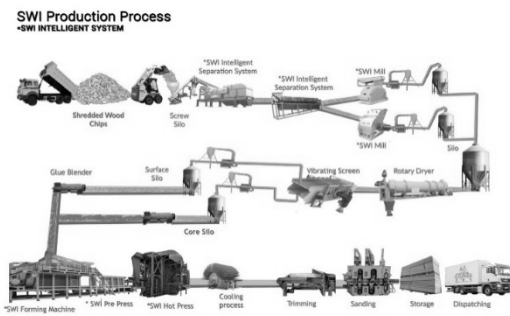

Figure 1- SWI Production Process

Functional Unit

For this study, material flows, fuel use, electricity use, and emissions data are normalized to a per production unit volume basis of 1.0 m³—the functional unit—of finished SDB ready to ship.

Lifecycle Assessment Modeling

The environmental impact analysis was done using openLCA v15 WARM software and include the EPA database to provide impacts for fuels, waste and electricity.

System Boundary Conditions

It is a complex method to separate the full production process into unit process; thus, the black box approach was adopted in this report calculation method. For onsite emissions only, the emissions considered are those that occur because of on-site combustion of fuels whether for process heat or operating equipment. For the cradle-to-gate with options emissions, all impacts are considered including those for the delivery of chemicals to SWI site. Note that the delivery of raw material is outside the scope of SWI (to maintain the SDB definition) and delivery of end products as well are outside the scope of SWI (to maintain the universal calculations of Carbon Dioxide Emissions).

Table 2- Illustration of **Mandatory** and **Optional** Elements and Information Modules adapted from EN 15804:2012

PRODUCT			END OF LIFE				BENEFITS
A1	A2	A3	C1	C2	C3	C4	D
RAW MATERIAL SUPPLY	TRANSPORT	MANUFACTURING	DEMOLITION	TRANSPORT	WASTE PROCESSING	DISPOSAL	REUSE-RECOVERY-RECYCLING POTENTIAL
M	M	O	O	O	O	O	O

A1: Raw Material supply; including processing of secondary material input if any – Applicable on to chemicals in SWI case.

A2: Transport of raw material and secondary material to the manufacturer if any – Applicable on chemicals in SWI case.

A3: Manufacturing of the construction products and all upstream processes from Cradle to Gate – Applicable to System Boundary Conditions

C1: Demolition of Building/Building Products – Optional – Not Considered

C2: Transport of the demolition to the end-of-life waste facility – Optional – Not Considered

C3: Waste processing operations for reuse, recovery or recycling – Optional – Not Considered

C4: Final Disposal of end-of-life construction product – Optional – Not Considered

D: Reuse/Recovery/Recycling Potential Evaluated as net impacts and benefits.

POSITIVE CARBON CALCULATIONS

The below table will include a listing of all inputs and outputs for the on-site manufacturing of SDB for the duration of October 2018 – September 2019.

End-Product: This parameter is to indicate in cubic meters the amount of end-product SDB produced during the duration of October 2018 – September 2019.

100% Post-Consumer Wood Required: This parameter is to indicate the total post-consumer raw wood required to manufacture the end product. Note that this factor is then used to calculate the source reduction – forest carbon storage calculation – and net recycling factors. The number accounted is in tons at 10% Water Content. In the following calculations, this number is then transformed to tree equivalence at 50-50 Water Content.

Glue Manufacturing: This parameter is to indicate

the kilometers driven to deliver both Chemical A and Chemical B to SWI site for the purpose of manufacturing.

Energy Purchase: This parameter is to indicate the amount of diesel used to manufacture the end products and the kilometers driven for the purpose of delivery.

Electricity Consumption: This parameter is to indicate the total electricity consumption in KWH for the purpose of manufacturing the End Product.

Water Consumption: This parameter is to indicate the total water consumption in Liters for the purpose of manufacturing the End Product.

Waste Generated: This parameter is to indicate the waste generated for the purpose of manufacturing the end product. Waste in this section is further divided into four subsections ¹⁻ Chemical Liquid Waste which is recycled on site using a water treatment plant. The outcome is then sent to sewerage disposal. ²⁻ Solid Waste which is sent for disposal as per municipality requirements ³⁻ Metals which are then sent for recycling through an approved list of scarp collectors. ⁴⁻ Dust Consumption which is the green energy used in both furnace and boiler.

Table 3- Data (Input-Output) for Calculation

DATA FOR OCTOBER 2018 – SEPTEMBER 2019			
END PRODUCT		37,500.00	CBM
RAW MATERIAL 100% POST CONSUMER WOOD REQUIRED		25,650.00	TONS
GLUE MANUFACTURING	RESIN	3170.00	TONS
ENERGY PURCHASE DIESEL	CONSUMPTION	411,192.00	L
	KILOMETERS DRIVEN	3,480.00	KM
ELECTRICITY CONSUMPTION		5,869,500.00	KWH
WATER CONSUMPTION		2,400,000.00	L
WASTE GENERATED	CHEMICAL LIQUID WASTE	432,500.00	L
	SOLID WASTE	11,036.67	KG
	METALS	361,200.00	KG
	DUST (GREEN ENERGY)	2,412,816.00	KG

Taking the calculations, the necessity requires the calculation of raw material use and waste generated per CBM. The below table summarizes the reported inputs and outputs to produce one CBM of SDB.

Table 4- Data (Input-Output) for Calculation per CBM

REQUIRED (INPUT/OUTPUT) PER CBM			
END PRODUCT		1.00	CBM
RAW MATERIAL POST CONSUMER WOOD		684.00	KG
GLUE MANUFACTURING	RESIN	8.45	KG
ENERGY PURCHASE		10.96	L
		0.093	KM

ELECTRICITY CONSUMPTION		156	KWH
WATER CONSUMPTION		64	L
WASTE GENERATED	CHEMICAL LIQUID	11.53	L
	SOLID WASTE	0.294	KG
	METALS	9.632	KG
	DUST GREEN ENERGY	64.34	KG

Note that the water meter is common between office area and manufacturing area – estimated at 50% for offices and 40% for production.

Further to the table above, the approach of the RMAM (Raw Material Acquisition and Manufacturing) will be taken in order to calculate the emissions from the manufacturing process. Note that the RMAM includes ¹⁻ GHG emissions from energy used during the RMAM process; ²⁻ GHG emissions from energy used to transport materials and ³⁻ non energy GHG emissions resulting from the manufacturing process. Noting that the RMAM calculation in WARM also incorporates the “retail transportation” which includes the average emissions from truck, rail, water and other modes of transportation required to deliver the material. As mentioned before, the case study will be accounting the cradle-to-gate approach thus negating the “retail transportation” factor.

The steps in calculating the RMAM are mentioned in WARM Version 14 page 11-7; following the same method – the below process will highlight the net positive emission factors from manufacturing process and material acquisition.

Step 1- Reference made to Exhibit 11-6

Exhibit 11-6: Raw Material Acquisition and Manufacturing Emission Factor for Virgin Production of Wood Products (MTCO₂E/Short Ton)

(a)	(b)	(c)	(d)	(e)
Material	Process Energy	Transportation Energy	Process Non-Energy	Net Emissions (e = b + c + d)
Dimensional Lumber	0.10	0.08	0.00	0.18
MDF	0.26	0.13	0.00	0.39

Table 5- Exhibit 11-6 in MTCO₂E/MT

MATERIAL (A)	PROCESS ENERGY (B)	TRANSPORTATION ENERGY (C)	PROCESS NON-ENERGY (D)	NET EMISSIONS (E)
DIMENSIONAL LUMBER	0.0907	0.0725	0	0.163
MDF	0.2358	0.1179	0	0.353
AVERAGE	0.1632	0.0952	0	0.258

Summary

Calculation reference to **Table 4** of Net Emissions from Manufacturing in MTCO₂/Ton is **positive 0.258 MTCO₂/Ton**

Table 6- Net Emissions from Manufacturing in MTCO2E

RAW MATERIAL ACQUISITION AND MANUFACTURING EMISSION FACTOR FOR VIRGIN PRODUCTION OF WOOD		
CBM PER YEAR	37,500	CBM
TONS PER YEAR	28,500	TONS AT 760 KG/M3 DENSITY
NET EMISSIONS FROM MANUFACTURING AT (0.258) FACTOR	7,353	MTCO2E

Table 9- Net Emissions from Electricity Consumption in MTCO2E

NET EMISSIONS FROM ELECTRICITY CONSUMPTION IN MTCO2E		
KWH PER YEAR	5,869,500	KWH PER YEAR
FACTOR	0.57	KgCO ₂ e/KWH
NET EMISSIONS FROM ELECTRICITY CONSUMPTION AT (0.57 KgCO ₂ /KWH)	3,345	MTCO2E

Step 2- Reference made to Exhibit 11-17

Exhibit 11-17: Utility GHG Emissions Offset from Combustion of Wood Products

(a)	(b)	(c)	(d)	(e)
Material	Energy Content (Million Btu per Short Ton)	Combustion System Efficiency (%)	Emission Factor for Utility-Generated Electricity (MTCO ₂ e/Million Btu of Electricity Delivered)	Avoided Utility GHG per Short Ton Combusted (MTCO ₂ e/Short Ton) (e = b x c x d)
Wood Products	16.6	17.8%	0.22	0.65

Table 7- Exhibit 11-17 in MTCO2E/MT

MATERIAL	COMBUSTION MTCO2E/MT
WOOD PRODUCTS	0.589

Summary

Calculation reference to **Table 4** of Net Emissions from Manufacturing in MTCO₂/Ton is **positive 0.589 MTCO₂/Ton**

Table 8- Net Emissions from Combustion in MTCO2E

UTILITY GHG EMISSIONS OFFSET FROM COMBUSTION OF WOOD PRODUCTS		
TONS PER YEAR	2,412	TONS COMBUSTED
NET EMISSIONS FROM COMBUSTION AT (0.589) FACTOR	1,422	MTCO2E

Reference made to **Table 3** of the report, Electricity consumption and diesel consumption are the sole types of energy used during the manufacturing process of SDB. In accordance to ISO 14025 and EN 15804; reference should be made to the United Arab Emirates as a benchmark for both usages of Electricity and Diesel.

Electricity Consumption: A specific dataset with the emissions factors corresponding to the UAE electricity mix for the duration of October 2018 to September 2019 has been developed for this LCA. The emission factor for electricity high voltage consumed is GWP 100a 0.57 KgCO₂e/KWH.

Diesel Consumption: A specific dataset with the emissions factors corresponding to the UAE diesel mix for the duration of October 2018 to September 2019 has been developed for this LCA. The emission factor for diesel combustion is GWP 100a 3.24 KgCO₂e/Liter.

Table 10- Net Emissions from Diesel Combustion in MTCO2E

NET EMISSIONS FROM DIESEL COMBUSTION IN MTCO2E		
LITERS PER YEAR	411,192	LITERS PER YEAR
FACTOR	3.24	KgCO ₂ e/L
NET EMISSIONS FROM DIESEL COMBUSTION AT (3.24 KgCO ₂ /KWH)	1,332	MTCO2E

Total Positive Carbon Dioxide Emission Per Year

Table 11- Total Positive Carbon Dioxide Emissions per Year

TOTAL POSITIVE CARBON DIOXIDE EMISSION		
NET EMISSIONS FROM MANUFACTURING AT (0.2584) FACTOR	7,353	MTCO2E
NET EMISSIONS FROM COMBUSTION AT (0.58955) FACTOR	1,422	MTCO2E
NET EMISSIONS FROM ELECTRICITY CONSUMPTION AT (0.57 KgCO ₂ /KWH)	3,345	MTCO2E
NET EMISSIONS FROM DIESEL COMBUSTION AT (3.24 KgCO ₂ /KWH)	1,332	MTCO2E
Total	13,453	Negative Carbon Dioxide Tons per Year

Note that reference to reports provided by the manufacturer on Stack Analysis – their Sulfur Dioxide (SO₂); Oxides of Nitrogen (NO_x) and Carbon Monoxide (CO) tested in accordance to USEPA EMC Method No.17 are considered to be negligible.

NEGATIVE CARBON CALCULATIONS

The below flow diagram will act as a summary for the approach taken throughout the paper for the calculation of negative carbon dioxide factor and the carbon-capture of SDB-type and Steel Wood Industries FZCO (Dubai Branch) a single site mill as per WARM v14 maintaining the fact that the NEDCCS is yet to be modelled.

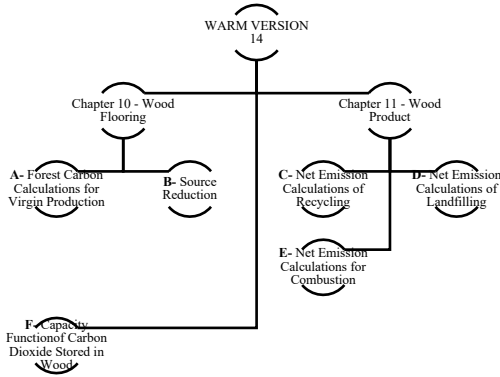

Figure 2 - (A, B, C, D, E, F) Synopsis and approach for carbon calculation

REFERENCE MADE TO CHAPTER 10 – WOOD FLOORING

This chapter describes the methodology used in EPA’s Waste Reduction Model (WARM) generating an estimate lifecycle GHG emissions factors for wood products – considering the starting point as waste generation.

The below Exhibit and flowchart (Exhibit 10-1 Life Cycle of Wood Flooring in WARM) highlights the life cycle in which SWI and SDB as a model can engage in. Knowing that this section is solely for solid hardwoods flooring. However, as per the CE Mark certificate issued by Euro Veritas having the harmonized standard tested in accordance to EN 13986:2004 + A1:2015 “Composite Wood Panels in Class P1,P3,P5,P7; SDB-type and Ox-products can replace OSB, Plywood, MDF, Particleboard, Chipboard and above all Solid Wood which is the main concern in this chapter. (Refer to Figure 2)

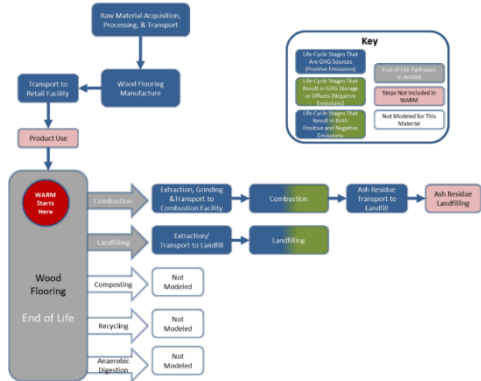

Figure 3- Exhibit 10-1 Life Cycle of Wood Flooring (edited)

Note that the recycling aspect is not modeled in Figure 3 knowing that WARM V.14 and EPA did not strongly believe that solid wood can be recycled the thing that Steel Wood Industries FZCO (Dubai Branch) defied through its technology.

Steel Wood Industries FZCO (Dubai Branch) by its product – SDB-type engages in the following materials management options as described in the referenced manual:

Forest Carbon Calculations for Virgin Production of Wood Flooring

Based on the above, the net emissions for wood products under each of the above-mentioned management option is highlighted in Exhibit 10-10 of the reference manual as referenced below: Note that Carbon Released from Wood Products and as defined in the reference, is directly related to the action of harvesting in which Steel Wood Industries FZCO (Dubai Branch) is not engaged in. SDB-type and as per definition is an environmental-friendly composite wood material, that is made up of 100% *post-consumer recycled random mix wood species* (including SDB waste panels excluding MDF). *Trees are not to be cut to manufacture SDB as the raw material” need 100% unusable wood residues and waste wood. Should there be a “non-environmental tree” proven and justified by international norms, the manufacturer should not engage in trimming and cutting of the tree and a third party needs to be engaged in such an operation to maintain the chain of custody requirements enforced by the FSC certification body or similar.* SDB is a recycled material manufactured in an SDB dedicated-intelligent line, that produces high mechanical properties when

compared to the mother-wood species. (APA Product Report PR-C509).

Based on the above, Steel Wood Industries FZCO (Dubai Branch) – **“the manufacturer” is not engaging in the cutting or transportation of raw materials and thus the Carbon Released from Wood Products is to be factored out to 0.**

Note that **One Metric Ton = 0.907 Short Tons** - Converting the above into Metric Tons is summarized in the below table.

Table 12- Forest Carbon Storage Calculations in MTCO2E/Ton

Material	Forest Carbon Released	Carbon Released from Wood Products	Net Carbon Released
Wood Flooring	-5.336	Note that as per FSC Recycled 100% Certificate of 100% Post Consumer Wood – SWI is not engaged in cutting trees and thus this is factored to be 0	-5.336

Summary

Calculation reference to **Figure (1, A)** of Forest Carbon Calculations for Virgin Products is **-5.336 MTCO2/Ton**

REFERENCE MADE TO CHAPTER 11 – WOOD PRODUCTS

This chapter describes the methodology used in EPA’s Waste Reduction Model (WARM); generating an estimate lifecycle greenhouse gas emissions factors for wood products – considering the starting point as waste generation.

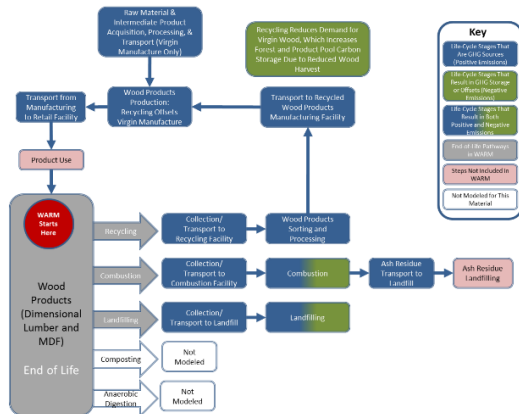

Figure 2-Exhibit 11-1 Life Cycle of Wood Products (edited)

The above Exhibit and flowchart (Exhibit 11-1: Life Cycle of Wood Products in WARM) highlights the

life cycle of Generic Wood Products (Not SWI-SDB flowchart).

As per the above figure, Steel Wood Industries FZCO (Dubai Branch) by its product – SDB-type engage in the following materials management options as described in the referenced manual.

Table 13- Compatibility with Chapter 11 of Wood

Method	Aim	Compatible
Source Reduction (Figure 1,B)	Aims at the reduction of dimensional lumber and wood manufactured, reducing the GHG emissions – considering the carbon storage that results in increased forest carbon stocks	Reference made to ECC Certificate issued by CPA – SWI and SDB engage in source reduction.
Recycling (Figure 1,C)	Though not strongly believed by EPA that dimensional lumber and MDF can be recycled in a closed loop system; EPA has developed a model if the recycled material avoids and offsets the GHG emissions	SWI with its technology can engage in recycling a random mix of wood as entitled in APA report and presented in FSC Recycled 100% certificate of TT-CCO-06091.
Combustion (Figure 1,E)	Aims at converting the energy in municipal solid waste (MSW) to deliver energy	Raw material entering SWI site either ends up as a final product; un-used fine dust from sanding and preparation is diverted to combustion for energy usage for boiler and furnace with green-energy stack emission compliance.
Landfilling (Figure 1,D)	Normal lifecycle of a wood product ends in a landfill, and because recycled, WARM factors the transportation energy being saved.	Raw material presented in the Incoming Material Form mentions that our wood is 100% post-consumer wood – also highlighted in FSC Certificate. Furthermore, SDB can be re-recycled maintaining SDB compliance allowing for circular economy.

Based on the above, the net emissions for wood products under each of the above-mentioned materials management option is highlighted in Exhibit 11-3 of the reference manual as referenced below:

Note that **One Metric Ton = 0.907 Short Tons** - Converting the above into Metric Tons is summarized in the below table:

Exhibit 11-3: Net Emissions for Wood Products under Each Materials Management Option (MTCO2E/Short Ton)

Material	Net Source Reduction (Reuse) Emissions for Current Mix of Inputs	Net Recycling Emissions	Net Composting Emissions	Net Combustion Emissions	Net Landfilling Emissions	Net Anaerobic Digestion Emissions
Dimensional Lumber	-2.03	-2.46	NA	-0.61	-1.01	NA
MDF	-2.23	-2.47	NA	-0.61	-0.88	NA

NA = Not applicable

Table 14- Exhibit 11-3 in MTCO2E/Ton

Material	Net Source Reduction (Reuse) Emissions for Current Mix of Inputs	Net Recycling Emissions	Net Combustion Emissions	Net Landfilling Emissions
Dimensional Lumber	-2.238	-2.712	-0.628	-1.041
MDF	-2.425	-2.723	-0.628	-0.970
Average	-2.331	-2.717	-0.628	-1.005

Summary

Calculation reference to **Figure 1 Section D,C,E** of Net Emissions for Wood Products under Materials Management Option Applicable to Steel Wood Industries FZCO (Dubai Branch) is: **-3.773 MTCO2/Ton**

Note that the **Net Source Reduction (Reuse) of Figure 1, B Emissions for Current Mix of Inputs Factor is factored with the Forest Carbon Storage Calculations of Figure 1 Section A.**

STEEL WOOD INDUSTRIES FZCO (DUBAI BRANCH) CAPACITY AND CARBON REDUCTION

General Capacity Calculations and Tree Equivalence

The calculation below will convert the dry (10% average random-mix post-consumer wood arriving at Steel Wood Industries Premises in UAE weather conditions) to equivalence of forest tree.

Table 15- Factor Calculation of Dry Wood Received vs. Useable Consumer Log Conserved

Per Day tons	96.25	10% water*
Water Content 10% (due to dry and hot UAE Weather and stored in outside bins by end users) *	9.63	tons
Net Wood (0% water assumptions by calculations)	86.63	tons
Water Content in Wood Fiber for Production (requirement for production)	1.44	tons
Total Wood for Production at average water retention in wood fiber	88.07	1.5% water
Internally Yield	0.92	%
Debarked Tree Equivalence Recycled (tree Average at 50 water to wood ratio)	173.25	50/50
Loss of Normal Drying (due to dry and hot UAE Weather and stored in outside bins by end users) *	77.00	tons
Wood Arriving at average 10% water content	96.25	tons
Ratio of Production to Original Tree	1.97	Full Tree

Ratio of Production requirements to Original Tree accounting for water content is: **1.97**

Noting that the useable part of the tree is the Timber part of the tree is in it debark log and bark, stumps, crowns and roots are not used for the purpose of wood manufacturing



Based on the above, the useable timber ratio is averaged to be: (51.2% (softwood) + 46.4% (hardwood)/2) = 49 %

Summary of Carbon Factors

Calculations Done are based on the below flowchart

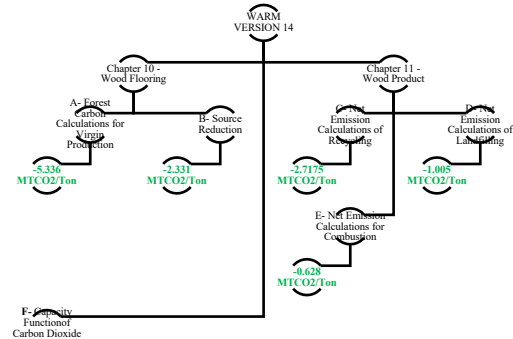

Figure 3- Synopsis and approach for carbon calculation with actuals

Based on Forest Carbon Storage Calculation

Table 16- Forest Carbon Storage Calculation Net Emission Factor

Net Carbon Released	Net Source Reduction (Reuse) Emissions for Current Mix of Inputs	Total
-5.336 MTCO ₂ /Ton	-2.331 MTCO ₂ /Ton	-7.667 MTCO ₂ /Ton

Table 17- Forest Carbon Storage Calculator based on SWI Capacity

Forest Carbon Storage Calculation		
CBM per Day	125	CBM
Average Density Produced	760	kg/cbm
Mass of Timber for Production at 1.5% at resin 10% in tons	85.5	tons
Working days	300	days
Mass of Timber Per Year	25,650	tons
Tree Equivalent of Recycled Post Consumer Annually (1.97 Factor from Table 5 above)	50,459	tree equivalent in tons not accounting for debarking of logs, tree crown, lost stump and roots.
Useable Timber Ratio (Softwood: 51.2%) (Hardwood: 46.4%). Average to:	49%	End of Life Not Modelled in WARM*
Actual Tree Conserved for Forest Carbon Storage	103,399	tree equivalent in tons accounting for debarking of logs, tree crown, lost stump and roots.
Forest Carbon Storage Calculation at Factor (-7.667)	-793,075	tons per year of Carbon Dioxide from Forest Carbon Storage Calculation

The conservation of the Tree in the Virgin Forest Does Not Only Economically Carbon Captures by Natural Means but also allows for the *natural synthesis of Oxygen* (along with sea planktons) for continued life on earth and a cleaner Environment. This model allows us to cover increased timber demands as a function of population increase while conserving our forests. This opens doors for a viable economical/environmental climate change solution. The essence of NEDCCS is not modelled in nowadays Direct Carbon Capture Models worldwide which is allowing for the natural synthesis of Oxygen. This factor will be very hard to model as the environmental issue is not only GHGs but also the depletion of oxygen without substitute to the lungs of earth -trees-.

Based on Recycling and Landfilling Calculation

Table 18- Net Emissions Factor Recycling and Landfilling

Net Recycling Emissions	Net Landfilling Emissions	Net Emissions
-2.7175	-1.005	-3.723MTCO ₂ /Ton

Table 19- Net Emissions factor Recycling and Landfilling on Actual SWI Capacity

Net Emissions (Recycling and Landfilling)		
CBM per Day	125	CBM
Average Density Produced	760	kg/cbm
Mass of Post-Consumer for Production at 1.5% at resin 10% in tons	85.5	tons
Working days	300	days
Mass of Post-Consumer Per Year	25,650	tons
Actual Post-Consumer Recycled Annually	50,459	Tons of Post-Consumer Recycled
Net Emissions (Recycling, Landfilling) at Factor (-3.723)	-188,212	tons per year of Carbon Dioxide Recycling, Landfilling

Based on Combustion Calculation

Table 20- Net Emissions Factor for Combustion

Net Combustion Emissions	Net Emissions
-0.628	-0.628 MTCO ₂ /Ton

Table 21- Net emissions Factor for Combustion on Actual SWI Capacity

Net Emissions (Combustion)		
Tons per Year (Additional to Capacity Calculations in Ton at 10% Water Content)	3,600	Tons
Net Emissions (Combustion) at Factor (-0.628)	-2,268	Tons per year of Carbon Dioxide from Combustion

Based on Carbon Stored (Sequestered) in Manufactured Panels

Every 1 m³ of SDB-type has stored negative 1290 kg of CO₂.

Table 22- Carbon Stored in end-product SDB for 300 days

Daily Capacity	Total for 300 Days
125 CBM	-48,375.00 MTCO ₂ E

Total Negative Carbon Dioxide Emission

Table 23- Total Negative Carbon Dioxide Emissions on Actual SWI Capacity

Total		
Forest Carbon Storage Calculation at Factor (-7.667)	-793,075	tons per year of Carbon Dioxide from Forest Carbon Storage Calculation
Net Emissions (Recycling, Landfilling) at Factor (-3.7225)	-188,212	tons per year of Carbon Dioxide Recycling, Landfilling
Net Emissions (Combustion) at Factor (-0.628)	-2,268	Tons per year of Carbon Dioxide from Combustion
Daily Net Carbon Stored in Manufactured Panels	-52,245	Tons per year of Carbon Dioxide stored in manufactured panels
Total	-1,031,930	Negative Carbon Dioxide Tons per Year

RESULTS ELABORATION

The total negative Carbon Dioxide Tons per year is factored based on the below requirements:

Steel Wood Industries FZCO (Dubai Branch) is not engaged in the initial transportation and raw material factoring out the “Carbon Released from Wood Products” as a **positive 1.18 MTCO2/Short Ton**.

Steel Wood Industries FZCO (Dubai Branch) engages in the source reduction for post-consumer raw material need, giving the necessary time for a tree to do its job, which is the “Forest Carbon Storage Calculation based on Net Carbon Released from Exhibit 10-10 and Net Source Reduction from Exhibit 11-3” as a **negative 7.667 MTCO2/MT**.

Steel Wood Industries FZCO (Dubai Branch) engages in recycling though as mentioned in page 11-6 of WARM; “EPA does not believe that recycling of MDF and dimensional lumber is a common practice in the US, WARM models an emission factors for the recycled credit input by assuming that the recycled material avoids or offsets the GHG emissions”; thus engaging in the **Net Recycling Emissions Factor**. Steel Wood Industries FZCO (Dubai Branch) also engages in offsetting the amount of wood materials sent to landfills at the end of life service by diverting the same to recycling thus engaging in the **Net Landfilling Emissions Factor**. Both landfilling and recycling factor out to **negative 3.773 MTCO2/MT**. Not to mention that Steel Wood Industries FZCO (Dubai Branch) raw material either ends up as an end-product or as a green energy to run its furnace and boiler; offsetting the

need for electricity production from powerplants thus engaging in the **Net Combustion Emissions Factor**. All the above factor to a Net Emissions of **negative -0.628 MTCO2/MT**.

Based on the above, the general factor was calculated and the total negative carbon dioxide tones per year at 125 CBM per day capacity is **negative -1,031,930 MTCO2**. (a non-modeled NEDCCS: RGW factor by SWI)

Table 24- General Emission Reduction Factor

General Factor		
Total	-1,031,930	Negative Carbon Dioxide Tons per Year
Tree Equivalent of Recycled Post Consumer Annually	54,572	Post-consumer Raw Material recycled at Steel Wood Industries as per capacity listed above that: Net Carbon Released and Net Forest Reduction for Forest Carbon Storage Calculation (Conserving the Virgin Tree in Our Forests) Net Recycling Emission Factor, Net Landfilling Emission Factor and Net Combustion Emission Factor (Eliminating Burden to Our Environment due to recyclability of SDB) Factor of Oxygen Synthesis is not Modeled in WARM
1 ton of Recycled Wood in CO2 Equivalence	-19.09	MTCO2/Ton

EMISSION FACTORS MODELLED PER FUNCTIONAL UNIT

Reference made to **Table 1** of this report, **Table 25** will give a summary on Emission factors modelled reference to the range of products provided by the manufacturer solely dependent on the product density accounting for 10% resin only. This factor is subject to change due to the fact that both Forest Carbon Storage Factor and Net Recycling - Landfilling factor are directly related to the amount of post-consumer wood used for the purpose of manufacturing.

Table 25- Emission Factor Calculations based on Product Density Specifications

	Ranges	SDB	Oxframes	Oxsawt	Oxnar-SAWT	Oxnar	Oxpanels	Oxtiles
Density (kg/CBM)	Lower Range	630.00	630.00	650.00	680.00	680.00	720.00	720.00
	Upper Range	830.00	700.00	700.00	740.00	700.00	800.00	800.00
	Average	730.00	665.00	675.00	710.00	690.00	760.00	760.00
Capacity per Day	CBM per Day	125.00	125.00	125.00	125.00	125.00	125.00	125.00
Mass of Post Consumer for Production at 1.5% at resin in 10% in tons	Lower Range	70.88	70.88	73.13	76.50	76.50	81.00	81.00
	Upper Range	93.38	78.75	78.75	83.25	78.75	90.00	90.00
	Average	82.13	74.81	75.94	79.88	77.63	85.50	85.50
Year	Working Days	300.00	300.00	300.00	300.00	300.00	300.00	300.00
Mass of Post Consumer per Year	Lower Range	21,262.50	21,262.50	21,937.50	22,950.00	22,950.00	24,300.00	24,300.00
	Upper Range	28,012.50	23,625.00	23,625.00	24,975.00	23,625.00	27,000.00	27,000.00
	Average	24,637.50	22,443.75	22,781.25	23,962.50	23,287.50	25,650.00	25,650.00
Actual Post Consumer Recycled (1.97 Factor)	Lower Range	41,887.13	41,887.13	43,216.88	45,211.50	45,211.50	47,871.00	47,871.00
	Upper Range	55,184.63	46,541.25	46,541.25	49,200.75	46,541.25	53,190.00	53,190.00
	Average	48,535.88	44,214.19	44,879.06	47,206.13	45,876.38	50,530.50	50,530.50
Actual Tree Conserved at 49% Useable Timber Ratio	Lower Range	85,483.93	85,483.93	88,197.70	92,268.37	92,268.37	97,695.92	97,695.92
	Upper Range	112,621.68	94,982.14	94,982.14	100,409.69	94,982.14	108,551.02	108,551.02
	Average	99,052.81	90,233.04	91,589.92	96,339.03	93,625.26	103,123.47	103,123.47
Forest Carbon Calculation (-7.67)	Lower Range	(655,661.73)	(655,661.73)	(676,476.39)	(707,698.38)	(707,698.38)	(749,327.69)	(749,327.69)
	Upper Range	(863,808.31)	(728,513.04)	(728,513.04)	(770,142.35)	(728,513.04)	(832,586.33)	(832,586.33)
	Average	(759,735.02)	(692,087.38)	(702,494.71)	(738,920.36)	(718,105.71)	(790,957.01)	(790,957.01)

Table 26- Emission Factor Calculations based on Product Density Specifications (Ctn 'd)

	Ranges	SDB	Oxframes	Oxsawt	Oxnar-SAWT	Oxnar	Oxpanels	Oxtiles
Net Emissions Recycling and Landfilling (-3.73)	Lower Range	(156,238.98)	(156,238.98)	(161,198.94)	(168,638.90)	(168,638.90)	(178,558.83)	(178,558.83)
	Upper Range	(205,838.65)	(173,598.86)	(173,598.86)	(183,518.80)	(173,598.86)	(198,398.70)	(198,398.70)
	Average	(181,038.81)	(164,918.92)	(167,398.90)	(176,078.85)	(171,118.88)	(188,478.77)	(188,478.77)
Net Emissions Combustion	Tons per Year	3,600.00	3,600.00	3,600.00	3,600.00	3,600.00	3,600.00	3,600.00
	(-0.63) Factor	(2,268.00)	(2,268.00)	(2,268.00)	(2,268.00)	(2,268.00)	(2,268.00)	(2,268.00)
Carbon Stored in Final Product	CBM per Day	125.00	125.00	125.00	125.00	125.00	125.00	125.00
	1290 kg CO2 per CBM	(48,375.00)	(48,375.00)	(48,375.00)	(48,375.00)	(48,375.00)	(48,375.00)	(48,375.00)
NEDCCS Model Total Negative MTCO2E	Lower Range	(808,175.71)	(808,175.71)	(833,950.33)	(872,612.27)	(872,612.27)	(924,161.52)	(924,161.52)
	Upper Range	(1,120,289.97)	(952,754.90)	(952,754.90)	(1,004,304.15)	(952,754.90)	(1,081,628.03)	(1,081,628.03)
	Average	(991,416.84)	(907,649.30)	(920,536.62)	(965,642.21)	(939,867.59)	(1,030,078.78)	(1,030,078.78)
Capacity per Year	Total CBM	37,500.00	37,500.00	37,500.00	37,500.00	37,500.00	37,500.00	37,500.00
Multiplication Factor (MTCO2E/CBM)	Lower Range	(21.55)	(21.55)	(22.24)	(23.27)	(23.27)	(24.64)	(24.64)
	Upper Range	(29.87)	(25.41)	(25.41)	(26.78)	(25.41)	(28.84)	(28.84)
	Average	(26.44)	(24.20)	(24.55)	(25.75)	(25.06)	(27.47)	(27.47)

With the above taken into account, the calculation of the general emission factor as a function of 1 cbm being a functional unit is relative to the below equation.

$$MF = 29.16 \ln(D) - 166.01$$

With MF: Multiplication Factor in MTCO₂E/CBM
 And D: Density of the final product in kg/m³

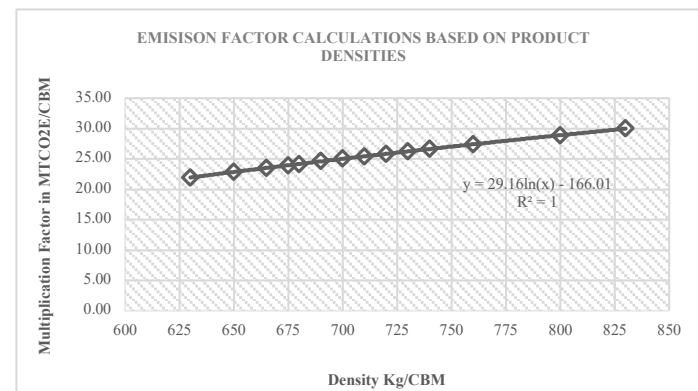

Graph 1- Emission Factor Calculations Based on Product Densities

NEDCCS: NATURAL ECONOMICAL DIRECT CARBON CAPTURE SYSTEM

FACTORS NOT MODELLED IN WARM

“While MDF can be made from a combination of virgin and post-consumer recycled materials, EPA has not located evidence that MDF is manufactured with recycled material in the United States. Dimensional Lumber cannot be manufactured from recycled material. Furthermore, the weak mechanical properties of particleboard and the enforcing limitations to MDF usage by a multitude of States and countries worldwide enforces the need for a *new product type* with superior and durable mechanical properties become eminent. Both composite materials mentioned earlier do not resolve the environmental impacts due to a multitude of limitations mentioned in WARM V.14 report. SDB opened a door for a recycled material that can be re-recycled maintaining healthy emission factors and preserving the environment by capturing carbon naturally and economically while providing the need for a durable and superior physical and mechanical property stronger than the mother tree. Note that until date the concept of recycling generally accounts or a weaker end-product, a concept defied in SDB-recycling and SWI technology.

There are a couple of factors which are essential to be respected in the NEDCCS model which are not mentioned out in WARM V.14 and openLCA V.15. This section will thoroughly discuss the necessary taking the NEDCCS model a step ahead regarding:

Note that Steel Wood Industries FZCO (Dubai Branch) will be referred to as the “manufacturer”

1- Logistics Prior to Cradle

The manufacturer is not engaging in the initial harvesting of material; neither in the transportation nor in segregation of it as it defies the initial definition of SDB “Steel Wood Density Board”. Knowing the same, the **positive 1.18 MTCO2E/Short Ton** referenced from Exhibit 10-10 in the forest Carbon Storage Calculations for Virgin Production of Wood Flooring is not only neutralized to be zero but rather considered as a factor for negative carbon dioxide calculations when discussing the cradle to gate life cycle assessment of the manufacturer. Factor value to be calculated accordingly. Positive values are to be part of the LCA of the harvesting party for Universal Calculations.

2- Timber Equivalence

The manufacturer and as per SDB definition are allowed to adapt as raw material only post-consumer wood. The timber equivalences calculated in WARM does not model the initial tree having 51% of its total volume (mass) not included in production (crown, stumps and debarks). Note that a tree is cut only for the use of its timber part.

This factor was adapted in NEDCCS model of Forest Carbon Storage Calculations where the mass of 100% post-consumer wood was further divided into the useable timber ratio based on (softwood 51.2% and hardwood 46.4%) averaging out to 49%. In other words, the factor is to be included in the tree equivalence calculation as per the equation below: (Note that the 51% remaining of the tree has biomass energy and carbon captured that is not used in SDB) which SWI is manufacturing.

NEDCCS PREMODEL

The below exhibit (reference to EPA methodologies exhibits) will highlight the NEDCCS model (Natural Economical Direct Carbon Capture System) model from Steel Wood Industries FZCO (Dubai Branch) perception where it engages not only in the life cycle of a product but rather introduces the circular economy where SDB can be re-recycled.

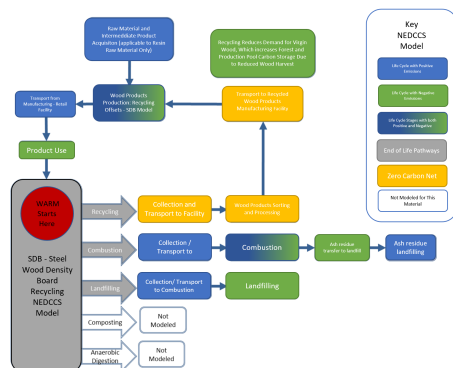

Figure 4- SDB NEDCCS:RGW Model (Recycle/Reuse)

Actual Trees Conserved for Production = [(Mass of Timber per Year in Tons) * 1.97]/0.49

**Note that this factor was accounted in our negative carbon calculations*

3- Energy Factor Function to Location

The calculations done in WARM do not consider the initial water content of the post-consumer material which is directly related to the method of storage of the post-consumer raw wood. Keep in mind that the current manufacturer being case studied is located in Dubai, where the yearly precipitation level is low and thus water content of material does not exceed 10% compared to an average of 50% water content in different areas overseas. The generic manufacturers will have to account for the use of energy to evaporate 40% of the water content (a factor that is levelled in Dubai due to natural evaporation by ambient heat and direct sunlight). Factors known for evaporation are further divided into a- Heat Capacity of Water $C=4200 \text{ J/kgC}$ and b- Latent Heat of Vaporization of Water $L_v=2256 \text{ KJ/kg}$ for a normal mill harvesting trees.

Taking this a step ahead; and considering the evaporation of 1000 Liters of Water at Dubai ambient average Temperature of 35 degrees Celsius

a- Energy Required ($35^\circ\text{C} \rightarrow 100^\circ\text{C}$)

$$Q_1 = m * C * \Delta T$$

$$Q_1 = 1000 * 4200 * (100 - 35)$$

$$Q_1 = 1000 * 4200 * 65$$

$$Q_1 = 273,000,000 \text{ J} = 273,000 \text{ KJ}$$

b- Energy Required ($100^\circ\text{C} \rightarrow 100^\circ\text{C}$)

$$Q_2 = m * L_v$$

$$Q_2 = 1000 * 2256$$

$$Q_2 = 2,256,000 \text{ KJ}$$

c- At least the dryer is set at 180°C (outside Dubai Model); Energy Required ($180^\circ\text{C} \rightarrow 100^\circ\text{C}$)

$$Q_3 = m * C * \Delta T$$

$$Q_3 = 1000 * 1996 * (180 - 100)$$

$$Q_3 = 1000 * 1996 * 80$$

$$Q_3 = 159,680,000 \text{ J} = 159,680 \text{ KJ}$$

d- Total Energy Required to Evaporate 1000 Liters of Water

$$Q_T = Q_1 + Q_2 + Q_3$$

$$Q_T = 273,000 \text{ KJ} + 2,256,000 \text{ KJ} + 159,680 \text{ KJ}$$

$Q_T = 2,688,680 \text{ KJ/Ton} = 2,688.68 \text{ KJ/Kg}$ not accounting for heat losses and the energy of the dryer. (0% loss of heat noting that the efficiencies of heat loss increase in hotter weather than in cooler weather while drying the 10%; dryer efficiency is higher and is estimated to be at 5-7% if not less; equivalent fossil fuel had to be consumed in conventional “particle board” or composite wood material mills LCA.) This is not accounting for the heat absorbed by the drier, heat losses and the ejects of hot air into the atmosphere.

4- Energy Within Burning Chamber

Noting that energy used in boilers and furnaces is composed of less than 10% water dust by natural transport (as drying also occurs in blower driven pneumatics while transferring wood-dust-to energy). This factor allows for a more efficient furnace and boiler as increased water content vs wood within the boiler and furnace cools the chamber. Dry matter increases the efficiency of boiler chamber when compared to the conventional “particle board” or composite wood material 50-50 water content burning of wood. This is proven by the fact that the original supplier of the furnace estimated a consumption of 40 tons/24hr – at SWI premises the furnace runs on an average of 3 tons/24hr.

The above factor is neglected in Dubai’s case knowing that natural circumstances are doing the necessary and wood is received at 10% Water Content. WARM and NEDCCS model should calculate the factor of energy saved and the same factor should be accounted in the **Net Recycling Emissions** during the process. The same factor should consider that the combustion of wood at 10% water content is different than that of wood at 50% water content. Energy saving is also a factor knowing that wood at 10% water content has a lower flashpoint and energy release than that at 50% water content which reversible engages in cooling. (*Remark: Factor is to be estimated as per location and precipitation percentage.*)

5- Weight to Weight Ratio Effect on Landfilling

It is noticeable to note that landfilling in deserts is different than landfilling in other countries due to the water content of wood. 1 ton of wood at 50-50% water content has 50% carbon; whereas 1 ton of wood at 90-10% water content has 90% carbon – knowing that carbon is stored in dry matter only. The recycled ton in SWI premises diverted from the landfill has 900 kgs of carbon stored which is captured during manufacturing. This factor is to be accounted for in the Net Landfilling and Net Recycling factors modelled previously by WARM.

6- Re-recyclability Factor Modelling

The NEDCCS model dictates that the end-product should be re-recycled maintaining the same physical and mechanical properties. The factor of re-recyclability is further not accounted in the Forest Carbon Calculations and thus shall be taken into account; adding to that the reuse factor which as per WARM is calculated in $(N-1) * \text{Source Reduction Factor}$ with N being the number of times used and 1 being the initial use of the board. Noting that not all incoming material to SWI is directly recycled. During the segregation process, post-consumer wood which is still in a useable condition (pallets) are reused before sent for recycling. This adds to the Source Reduction, Forest Carbon Storage and Recycling factor extending the Life Cycle of the post-consumer raw material.

7- Major changes between the conventional manufacturing and SWI premises are noted out in the table below:

Table 27- Comparison of Conventional Manufacturing vs. NEDCCS

Comparison (Conventional vs. NEDCCS)		
	Conventional	NEDCCS
Raw Material Water Content	Location Dependent – Average of 50%	Average of 10%
Energy Required to Evaporate 1000 L of Water at 100% dryer Efficiency	5688.68 KJ/Kg	Natural Evaporation by Sun to 10% average
Dryer Temperature and Efficiency and ambient temperature	Lower Efficiency at 50% WC (estimated at 40 tons/24hr)	Highly Efficient at 10% WC (estimated at 3tons/24hr)
Transportation and Harvesting of Raw Material	By manufacturer – through cutting controlled trees	Only accepts 100% post-consumer trees covering demands and allowing for natural carbon-capture
Source Reduction Factor	Doesn't engage	Engages in the plantation of virtual trees
Weight to Weight Factor	50% Stored Carbon in Dry Matter at 50-50 WC	90% Stored Carbon in Dry Matter at 90-10 WC
Oxygen Factor	Doesn't engage	Engages in the natural synthesis of oxygen (only model)

ECONOMICAL IMPACT OF NEDCCS “VIRTUAL TREES”

The NEDCCS: RGW opens doors for nations worldwide to engage in as it has proven to have a positive economic impact. The return on investments as well as the positive effect on the environment would relieve many governments and economies worldwide. It provides an economical solution for climate change and commitments to UNFCCC programs by nations that endorsed the Paris Agreement. In addition, it would play in the favor of governments and would allow less withdrawals from the Convention thus providing a better future for the coming generations.

Steel Wood Industries operates from the desert dunes in Dubai. Thousands of Square miles of desert extend in the Middle East from the Arabian Gulf to North Africa. Forestation in this region is simply impossible and comes with a huge amount of positive GHG. Forestation requires a couple of factors to become feasible; good soil type, acceptable ambient temperatures and sweet water. Soil in deserts is made of desert sand which is not a good platform for vegetation. The transport of soil over existing desert sand results in positive carbon emissions. Temperatures reach up to 50 degrees centigrade in June, July and August in some areas in the UAE thus many plant species dry-out before benefitting from their natural carbon-capture cycle. Water is scarce and agriculture in desert areas where sweet water is scarce would require desalination plants from sea water for irrigation. The overall vegetation in desert regions is an expensive and almost impossible solution for climate change.

The NEDCCS: RGW model, however, can be implemented in these regions. We witness a lot of construction in real estate and thus imports of huge amounts of plywood for molding concrete for towers and buildings. Once these materials are reused and recycled, they enter the NEDCCS: RGW. The equivalent amount of negative carbon in the NEDCCS: RGW saves hundreds of thousands of trees annual. In other words, the tree equivalent saved by countries that cannot engage in a feasible vegetation can be considered as “Virtual-Trees” planted anywhere on the globe to cover the increased demands and lessen the tension from our forests. Noting that GHGs emissions will be extremely positive as water has the highest heat capacity of 4200 J/kgC compared to other liquids

known to humans. The NEDCCS: RGW would invite a multitude of countries in the Middle East, and dry States in North America, Australia, Africa etc. to make use of the post-consumer wood. Once the model becomes viral, we can be wishful and witness a decrease in Carbon Dioxide in the atmosphere by natural tree means and thus lower the concentration of GHG in the atmosphere with time and hopefully reach the reverse global warming before it is too late.

The need for SDB and the NEDCCS: RGW is now a global need. A multitude of restrictions in deforestation is now set by the UN and certain governments. The re-recyclability and thus the re-use of SDB can always play a role in covering demands. Our local studies for post-consumer wood which end up in landfills are millions of tons annually locally. This resource is now being buried and is converting valuable land into landfills.

REFERENCES

- ANSI (2009) Particleboard. American National Standard. ANSI A208.1-2009. Composite Panel Association, Gaithersburg, MD. 15 pp.
- BSI (2008) PAS 2050: Specification for the assessment of the life cycle green house gas emissions of goods and services. British Standards Institution, London, UK. 36 pp.
- CORRIM (2001) Research guidelines for life cycle inventories. Consortium for Research on Renewable Industrial Materials. CORRIM, Inc. University of Washington, Seattle, WA. 2 Apr. 47 pp.
- CPA (2005) 2004 North American shipments report— Particleboard, medium density fiberboard, and hard- board. Composite Panel Association, 18922 Premiere Court, Gaithersburg, MD. 20879.
- Ecoinvent (2004) Ecoinvent database and methodology. Data version 1.1. June. http://www.ecoinvent.org/fileadmin/documents/en/01_OverviewAndMethodology.pdf (15 January 2008).
- EIA (2007) Net generation by energy source by type of producer, 1995 through 2006. Energy Information Administration. <http://www.eia.doe.gov/cneaf/electricity/epa/epat1p1.html> (27 November 2007).
- FAL (2004) The Franklin Associates life cycle inventory database. SimaPro7 Life-Cycle Assessment Software Package version 7.1 Franklin Associates Ltd. June. <http://www.pre.nl/download/manuals/DatabaseManualFranklinUS98.pdf> (15 January 2008).
- IPCC (1996) Climate change 1995—Impacts, adaptations and mitigation of climate change: Scientific–technical analyses. Intergovernmental Panel on Climate Change. Panel on Climate. Cambridge University Press, Cambridge, UK.
- IPCC (2001a) Climate change 2001: The scientific basis. Contribution of Working Group I to the Third Assessment Report. Panel on Climate. Intergovernmental Panel on Climate Change. Cambridge University Press, Cambridge, UK.
- IPCC (2001b) Climate change 2001: The mitigation. Contribution of Working Group III to the Third Assessment Report. Panel on Climate. Intergovernmental Panel on Climate Change. Cambridge University Press, Cambridge, UK.
- IPCC (2007) Chapter 2 Changes in atmospheric constituents and radiative forcing. In The physical science basis. Contribution of Working Group I to the Fourth Assessment Report. Intergovernmental Panel on Climate Change. <http://www.ipcc.ch/pdf/assessment-report/ar4/wg1/ar4-wg1-chapter2.pdf> (15 December 2008).
- ISO (2006a) Environmental management—Life cycle assessment—Principles and framework. ISO 14040. First Edition 2006-06-31. International Organization for Standardization, Geneva, Switzerland. 32 pp.
- ISO (2006b) Environmental management—Life cycle assessment—Requirements and guidelines. ISO 14044. First Edition 2006-07-01. International Organization for Standardization, Geneva, Switzerland. 46 pp.
- Johnson LR, Lippke B, Marshall JD, Comnick J (2005) Life-cycle impacts of forest resource activities in the Pacific Northwest and southeast United States. Wood Fiber Sci 37(CORRIM Special Issue):30 – 46.
- Kline ED (2005) Gate-to-gate life inventory of oriented strand board. Wood Fiber Sci 37(CORRIM Special Issue):74 – 84.
- Milota MR, West CD, Hartley ID (2005) Gate-to-gate life inventory of softwood lumber production. Wood Fiber Sci 37(CORRIM Special Issue):47 – 57.
- PRE' Consultants (2007) SimaPro7 Life-cycle assessment

software package, Version 7.10. Plotterweg 12, 3821 BB Amersfoort, The Netherlands. http://www.pre.nl/sima_pro/manuals/default.htm (27 February 2007).

Skog KE (2008) Sequestration of carbon in harvested wood products for the United States. *Forest Prod J* 58(8):56 – 72. USDOE (2007) Net generation by energy source by type of producer. US Department of Energy. http://www.eia.doe.gov/cneaf/electricity/epa/generation_state.xls (15 January 2007).

USEPA (2003) Wood waste combustion in boilers. 20 pp. In AP42 Fifth Edition, Volume I, Chapter 1: External combustion sources. US Environmental Protection Agency. <http://www.epa.gov/ttn/chief/ap42/ch01/index.html> (18 January 2008).

USEPA (2004) National emission standards for hazardous air pollutants: Plywood and composite wood products; effluent limitations guidelines and standards for the timber products point source category; list of hazardous air pollutants, lesser quantity designations, source category list. <http://www.epa.gov/EPA-WATER/2004/July/Day-30/w6298a.htm> (10 December 2007).

Wilson JB (2008) Particleboard: A life-cycle inventory of manufacturing panels from resource through product. Phase II final report. Consortium for Research on Renewable Industrial Materials. May CORRIM, Inc. University of Washington, Seattle, WA. 58 pp.

Wilson JB (2009) Life-cycle inventory of resins used in wood composites manufacture. Phase II final report. Consortium for Research on Renewable Industrial Materials. March. CORRIM, Inc. University of Washington, Seattle, WA. 88 pp.

Wilson JB (2010) Life-cycle inventory of formaldehyde-based resins used in wood composites in terms of resources, emissions, energy and carbon. *Wood Fiber Sci* 42(CORRIM Special Issue):125 – 143.

Wilson JB, Sakimoto ET (2005) Gate-to-gate life-cycle inventory of softwood plywood production. *Wood Fiber Sci* 37(CORRIM Special Issue):58 – 73.

CONTACT INFORMATION

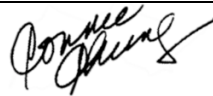
EPD OWNER	STEEL WOOD INDUSTRIES FZCO (DUBAI BRANCH)		
	PLOT OF LAND TP010223 NATIONAL INDUSTRIES PARK		
	INDUSTRIAL LICENSE NUMBER 679603		
	PHONE +971 4 880 7576		
	FAX +971 4 880 7574		
EPD AUTHOR	P.O. BOX 17260		
	GHASSAN FAROUK AFIOUNI		
	MANAGING PARTNER INVENTOR		
	CHEMIST, INDUSTRIAL CHEMIST WITH A VARIETY OF SELF-FUNDED PROJECTS (OVER 25 YEARS OF RESEARCH) NOT LIMITED TO ENVIRONMENT-FRIENDLY RESEARCH AND DEVELOPMENT PROJECTS TO INTRODUCING A NEW COMPOSITE WOOD MATERIAL TYPE SDB, CELLULOSIC FIRE SAFETY PRODUCTS AND PROCESSES (BARDAN TECHNOLOGY) AND DATE-PALM TREE RAW MATERIAL (AKMAM TECHNOLOGY) AND MATRICES WITH SDB COMBINATIONS, PLYWOOD RESEARCH AND NEW CELLULOSIC COMPOSITE MATERIAL TYPES, IN-SITU GROUNDWATER REMEDIATION OF CHLORINATED-HYDROCARBONS (FUNDED BY NASA VIA UNIVERSITY OF CENTRAL FLORIDA AND UNIVERSITY OF SOUTH FLORIDA), ENVIRONMENT-FRIENDLY CONDUCTIVE POLYMERS AS MILLIMETER WAVE SCREENING MATERIAL (FUNDED BY US ARMY VIA UNIVERSITY OF CENTRAL FLORIDA), PROTOTYPING OF PROCESSES AND MACHINERY, ENVIRONMENT-FRIENDLY PLASTICS FOR GRP AND GRE RESINS AND LINERS SUITABLE FOR 3-D PRINTING OF A MOBILE GLASS REINFORCED WINDING SYSTEM MGWS ON SITE, ENVIRONMENT-FRIENDLY RESINS FOR COMPOSITE WOOD MATERIAL, ENVIRONMENT-FRIENDLY HEAT-TRANSFER UNITS, SOLAR TECHNOLOGY, ENVIRONMENT-FRIENDLY INSECTICIDES, WITH MULTI AWARDS AND PATENTS ETC.		
	STEEL WOOD INDUSTRIES FZCO (DUBAI BRANCH)		
	PLOT OF LAND TP010223 NATIONAL INDUSTRIES PARK		
	INDUSTRIAL LICENSE NUMBER 679603		
	PHONE +971 4 880 7576		
	FAX +971 4 880 7574		
	P.O. BOX 17260		
	EMAIL: MPI@STEELWOODINDUSTRIES.COM		
	EPD OPERATOR AND VERIFIER	DECLARATION HOLDER	STEEL WOOD INDUSTRIES FZCO (DUBAI BRANCH)
		DECLARATION NUMBER	13CA24184.1911.4
DECLARED PRODUCT		STEEL WOOD DENSITY BOARD AND OXPRODUCTS	
REFERENCE PCR		UNE-EN 15804:2012 FPI INNOVATION PCR FOR NORTH AMERICAN STRUCTURAL AND ARCHITECTURAL WOOD PRODUCTS V.2.0 2015	
REFERENCE PCR STANDARD		UNE-EN 15804:2012 + A1:2014	
DATE OF ISSUE		NOVEMBER 25, 2019	
PERIOD OF VALIDITY		5 YEARS	
DECLARATION CONTENT		PRODUCT DEFINITION AND INFORMATION ABOUT BUILDING PHYSICS INFORMATION ABOUT BASIC MATERIAL AND THE MATERIALS ORIGIN DESCRIPTION OF THE PRODUCTS MANUFACTURE INDICATION OF PRODUCT PROCESSING INFORMATION ABOUT THE INUSE CONDITIONS LIFE CYCLE ASSESMENT RESULTS TESTING RESULTS AND VERIFICATIONS	
THE EPD REVIEW AND VERIFICATION WAS CONDUCTED BY	CONNIE KLINKAM		
	DIRECTOR, LABORATORY SERVICES		
	COMPOSITE PANEL ASSOCIATION		
THIS DECLARATION WAS INDEPENDENTLY VERIFIED IN ACCORDANCE TO ISO 14025 BY THE COMPOSITE PANEL ASSOCIATION <input checked="" type="checkbox"/> INTERNALLY <input type="checkbox"/> EXTERNALLY			
	THIS LIFE CYCLE ASSESMENT WAS INDEPENDENTLY VERIFIED IN ACCORDANCE WITH ISO 14044 AND THE REFERENCE PCR BY: PAUL FIRTH		
		